

Ø2.95
[75]

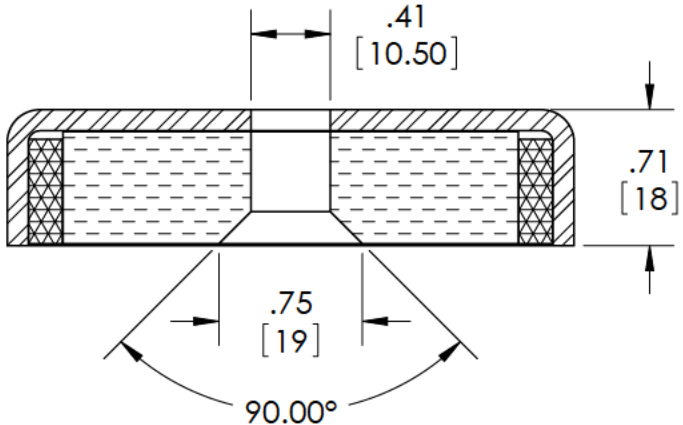

SECTION A-A

DIMENSIONS SHOWN AS: inches [millimeters]		ALB Materials Inc	
TOLERANCES: FRACTIONAL ± 0.030 ANGULAR: ± 0.5° TWO PLACE DECIMAL ± 0.010 THREE PLACE DECIMAL ± 0.005		TITLE: MOUNTING MAGNET STYLE A	
MATERIAL	SEE PRODUCT PAGE	SIZE	DWG. NO.
FINISH	SEE PRODUCT PAGE	A	MM-A-75
SCALE: 1:1		DO NOT SCALE DRAWING	REV 0
		SHEET 1 OF 1	

PROPRIETARY AND CONFIDENTIAL: THE INFORMATION CONTAINED IN THIS DRAWING IS THE SOLE PROPERTY OF ALB MATERIALS INC. ANY REPRODUCTION IN PART OR AS A WHOLE WITHOUT THE WRITTEN PERMISSION OF ALB MATERIALS INC IS PROHIBITED