

ALB Materials Inc

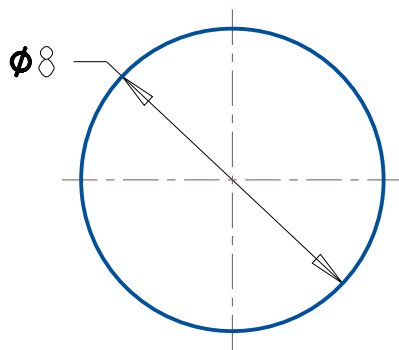

UNLESS OTHERWISE SPECIFIED,
DIMENSIONS ARE IN MM

ALB Materials Inc

TOLERANCES:
FRACTIONAL 0.1
ANGULAR: 0.5
ONE PLACE DECIMAL 0.1
TWO PLACE DECIMAL 0.10

TITLE:
DISC/CYLINDER MAGNET

SIZE	DWG. NO.	REV
A	D8x4mm	0

PROPRIETARY AND CONFIDENTIAL: THE INFORMATION CONTAINED IN THIS DRAWING IS THE SOLE PROPERTY OF ALB MATERIALS INC. ANY REPRODUCTION IN PART OR AS A WHOLE WITHOUT THE WRITTEN PERMISSION OF ALB MATERIALS INC. IS PROHIBITED.

MATERIAL
SEE PRODUCT PAGE

SCALE: 5:1	DO NOT SCALED RAWING	SHEET 1 OF 1
------------	-------------------------	--------------

5

4

3

2

1