

# ALB Materials Inc

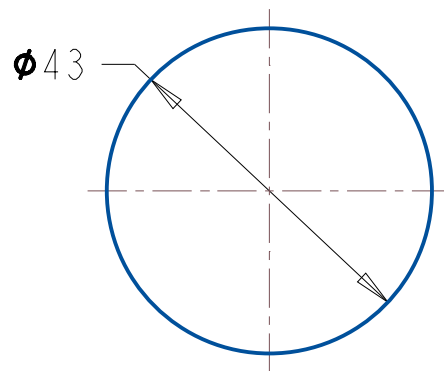

UNLESS OTHERWISE SPECIFIED,  
DIMENSIONS ARE IN MM

**ALB Materials Inc**

TOLERANCES:  
FRACTIONAL 0.1  
ANGULAR: 0.5  
ONE PLACE DECIMAL 0.1  
TWO PLACE DECIMAL 0.10

**TITLE:**  
**DISC/CYLINDER MAGNET**

SIZE	DWG. NO.	REV
<b>A</b>	<b>D43x6mm</b>	<b>0</b>

**PROPRIETARY AND CONFIDENTIAL:** THE INFORMATION CONTAINED IN THIS DRAWING IS THE SOLE PROPERTY OF ALB MATERIALS INC. ANY REPRODUCTION IN PART OR AS A WHOLE WITHOUT THE WRITTEN PERMISSION OF ALB MATERIALS INC. IS PROHIBITED.

**MATERIAL**  
**SEE PRODUCT PAGE**

SCALE: 1:1	DO NOT SCALED RAWING	SHEET 1 OF 1
------------	-------------------------	--------------

5

4

3

2

1